

2023 New Keys



SEPTEMBER

TOYOTA

HONDA

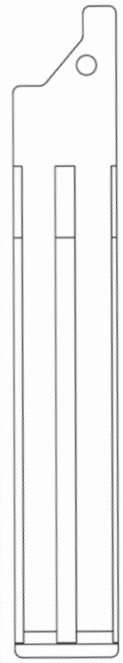

T7497

FORTUNER

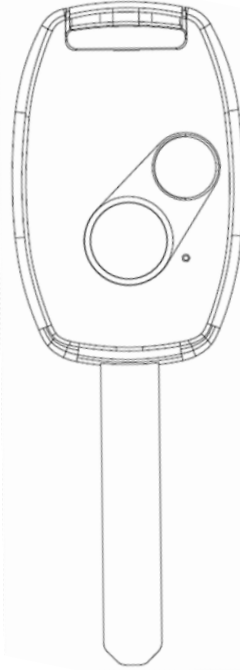

T7502

AMAZE (KEY SHELL)

HONDA

OKAYA

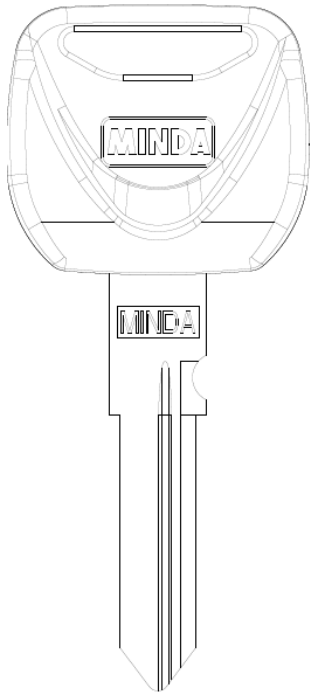

T7505

TWISTER

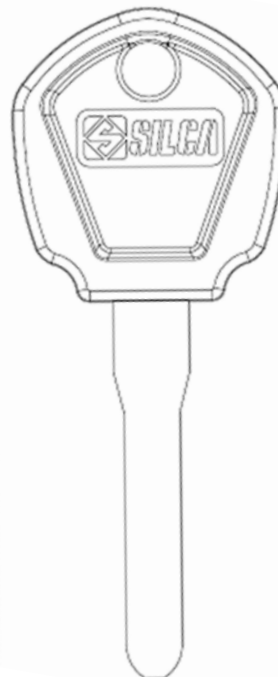

T7501

FAAST
EV

Disclaimer

Important In compliance with current regulations relating to industrial property, we hereby state that the trade-mark or trade names mentioned in our catalogue are the exclusive property of authorized manufacturer of locks and users. Said trade-marks or trade names are nominated only for the purpose of information so that any lock for which our keys are made can be rapidly identified. This catalogue is reserved exclusively for professional key cutters who use Minda Silca products. All information and illustration in this catalogue are for guidance only. MindaSilca reserves the right to alter designs, dimensions or prices without prior notice. The content of this catalogue are fully protected by copyright and may not be copied or reproduced in any form, without written permission from Minda-Silca. Any infringement will be dealt with under Indian law.

2023 New Keys



SEPTEMBER

INFINITY

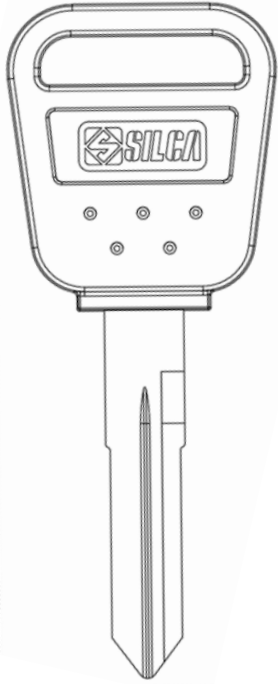

T7503

E1 EV

ALBA URMET

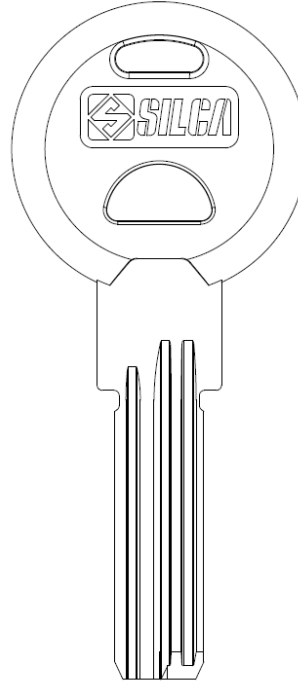

T7504

SECURITY
LOCK

SOLO

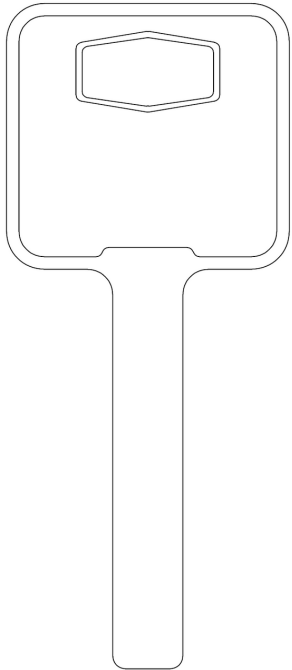

A1049Z

SECURITY
LOCK

Disclaimer

Important In compliance with current regulations relating to industrial property, we hereby state that the trade-mark or trade names mentioned in our catalogue are the exclusive property of authorized manufacturer of locks and users. Said trade-marks or trade names are nominated only for the purpose of information so that any lock for which our keys are made can be rapidly identified. This catalogue is reserved exclusively for professional key cutters who use Minda Silca products. All information and illustration in this catalogue are for guidance only. MindaSilca reserves the right to alter designs, dimensions or prices without prior notice. The content of this catalogue are fully protected by copyright and may not be copied or reproduced in any form, without written permission from Minda-Silca. Any infringement will be dealt with under Indian law.